

Modelo

30



Dimensões

Características

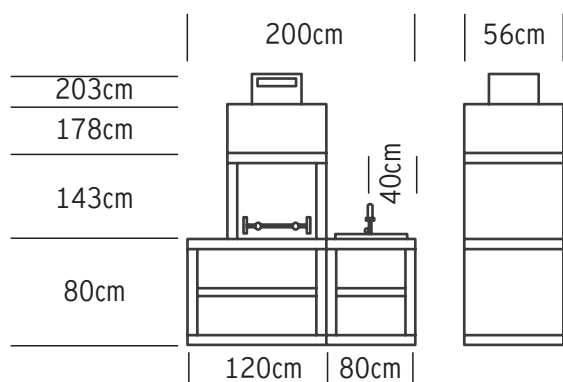

Preto



Castanho



1025 Kg



2 ANOS Garantia

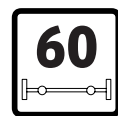

60 Grelha

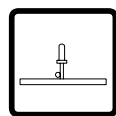

Pio